

Magnetic MiMo Cellular Antenna

LP[G]AMM-BC3G-26

Magnetic MiMo Cellular Antenna

Magnetic mount

2 x 2 MiMo Cellular/LTE

Cost effective solution for M2M and IOT applications

Optional GPS/GNSS Element

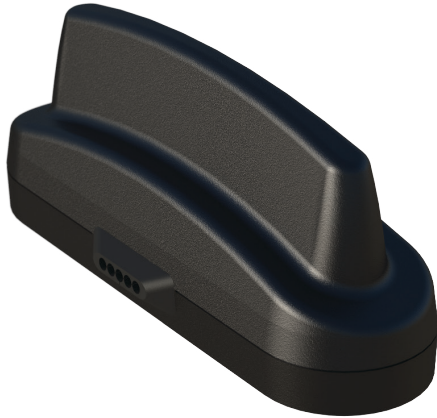

The LP[G]AMM-BC3G-26 range has been designed to provide MiMo Cellular / LTE antenna function for IOT and M2M applications. The compact, robust low-profile housing is weatherproof and contains two antenna elements with effective isolation and correlation covering all current global cellular and LTE bands in freq. range 698-960/1710-3800MHz.

The LG version includes an active 26dB gain GPS/GNSS/Galileo/Beidou antenna for applications which require position or timing function.

The antenna is designed to be mounted magnetically but can be fitted on a non-conductive panel if required* and offers easy, quick, secure and weatherproof installation. Supplied with integrated RG174 cables and SMA plug connectors, the antenna will offer plug and play connectivity with many different terminals.

* There will be no magnetic retention

Technical Drawing

LPAMM-BC3G-26-4SP shown

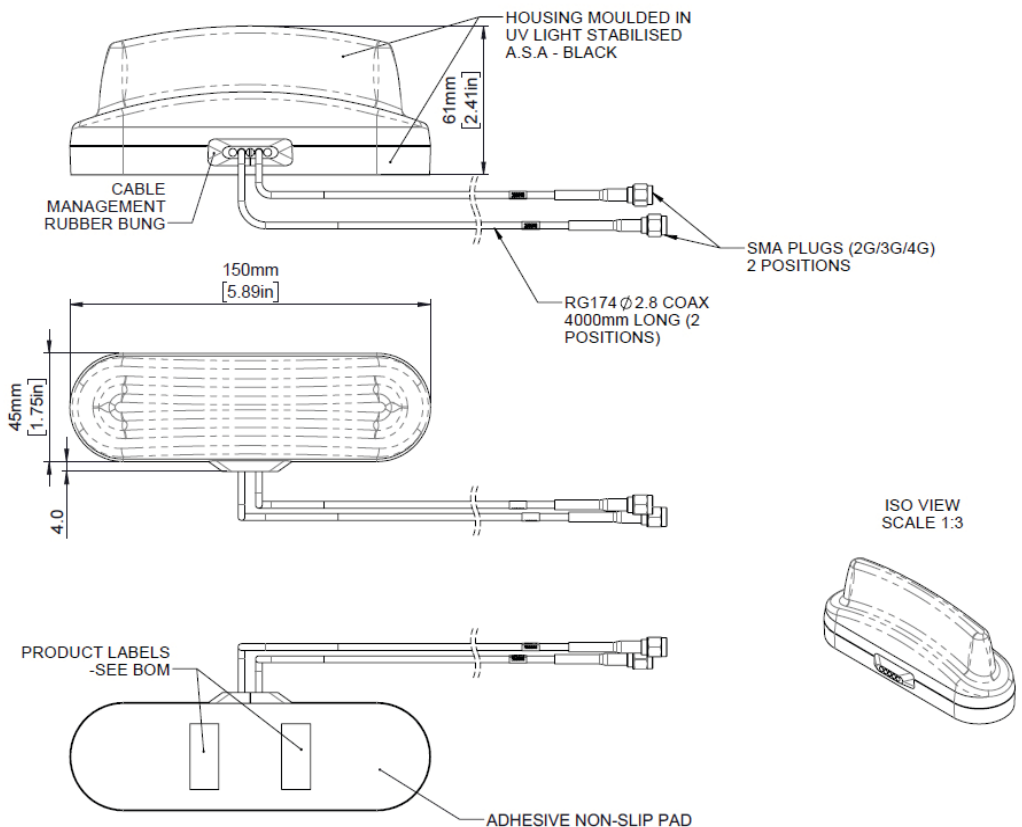

Magnetic MiMo Cellular Antenna

LP[G]AMM-BC3G-26

Product Data

Part No.		LPAMM-BC3G-26-3SP	LGAMM-BC3G-26-3SP
Electrical Data			
Frequency Range (MHz)	Elements 1 & 2	698-960 / 1710-3800	
	Element 3	-	1562-1612MHz
Peak Gain: Isotropic †	Element 1 & 2: 698-960MHz	1.5dBi	
	Elements 1 & 2: 1710-2170MHz	4.5dBi	
	Elements 1 & 2: 2500-3800MHz	5dBi	
Pattern	Omni-directional		
Nominal Impedance	50Ω		
Max input power (W)	20		
GPS/GNSS Data - Element 3			
Frequency Range (MHz)	-	1562-1612MHz	
LNA Gain (dB)	-	26	
Polarisation	-	Right Hand Circular	
Operating Voltage	-	3-5VDC (Fed via Coax)	
Current	-	Typical <20mA	
Mechanical Data			
Dimensions (mm)	Height	61 (2.4")	
	Length	150 (5.90")	
	Width	45 (1.77")	
Operating Temp (°C)	-30° / +70°C (-22° / 158°F)		
Material	UV Stable ASA Plastic		
Colour	Black		
Typical Weight (g)	360		
Mounting Data			
Fixing	Magnetic Mounting		
Recommended Max Vehicle Speed	80Mph / 130Kmph		
Cable Data			
Elements 1 & 2: Cell / LTE	Cable Type	RG174	
	Diameter (mm)	2.8 (0.1")	
	Length (m)	3 (9.8')	
	Termination	2x SMA Plugs	

† Peak gain simulated off a groundplane and does not include cable attenuation

Magnetic MiMo Cellular Antenna

LP[G]AMM-BC3G-26

Electrical Data

Typical VSWR - Elements 1&2*

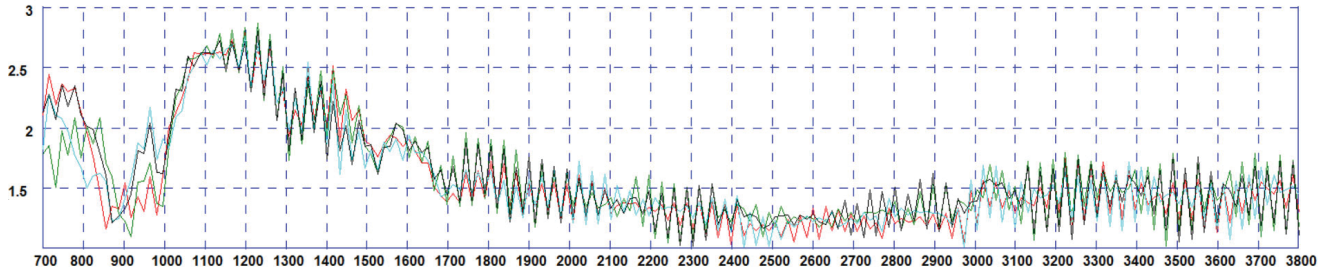

* VSWR measured with 3m (10') of RG174 cable Green and Red Plots = Elements 1&2 in free space Black and Blue plots = Elements 1&2 on a 400x400mm ground plane

Typical Isolation - Elements 1&2*

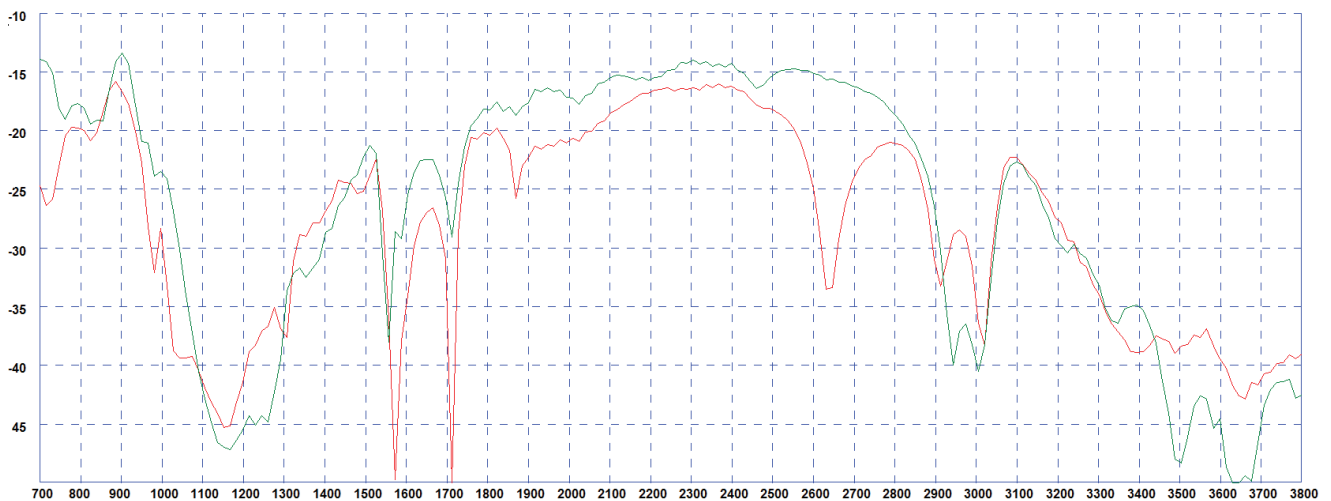

* Isolation measured with 3m (10') of RG174 cable Red Plot = mounted on a 400x 400mm (1' 4" x 1' 4") ground plane Green Plot = free space

Element 3: Typical E Plane Pattern (1602MHz)

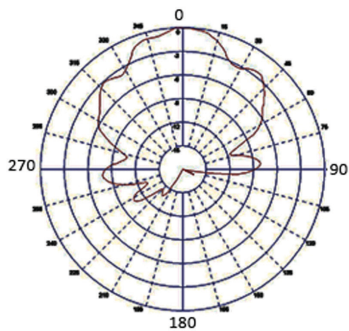

Typical 3D Radiation Patterns - Cell / LTE Elements 1&2

3D Gain Plot Side (700MHz)

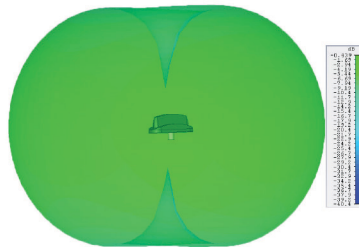

3D Gain Plot Top (700MHz)

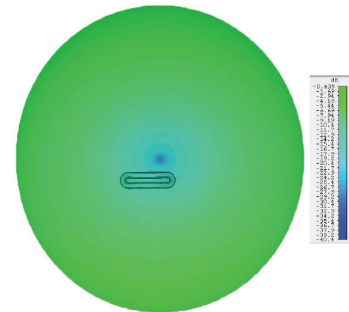

3D Gain Plot Side (800MHz)

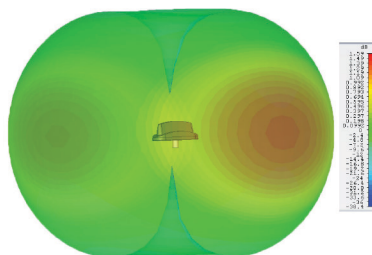

Magnetic MiMo Cellular Antenna

LP[G]AMM-BC3G-26

Radiation Patterns

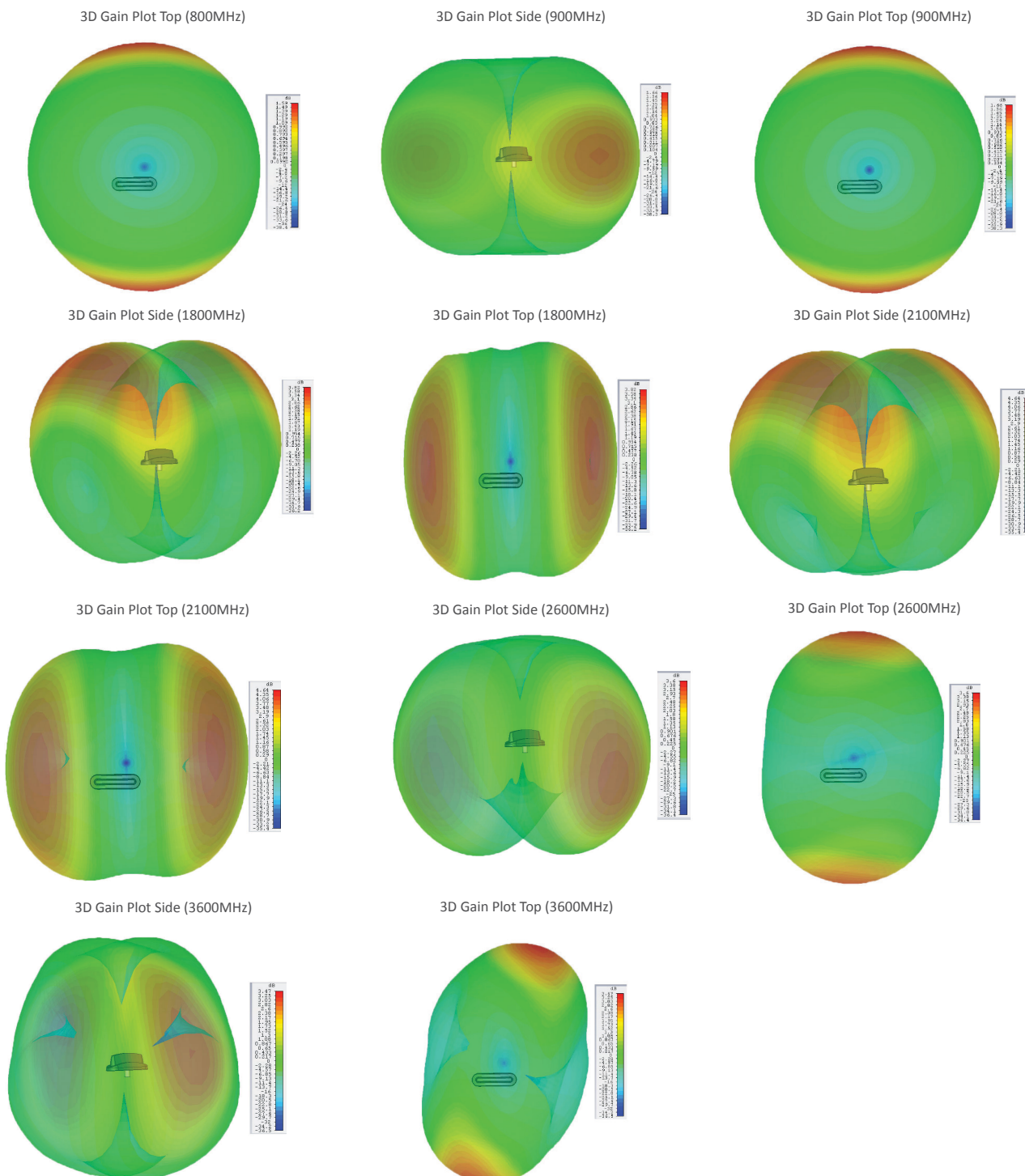

*3D radiation patterns simulated in CST Microwave Studio on a 600x600mm (2' X2') ground plane with both elements fed together.
 † Element 1&2 Patterns simulated in CST Microwave Studio in free space excluding cable loss. Element 3 pattern measured in free space.